

Phaeton + RGB-LE

SPECIFICATION



- . MODEL: RGB-LE-V3

- . PRODUCT CODE : RB-080125-013

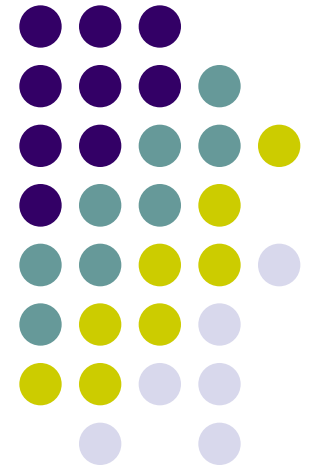

-Pre- Caution

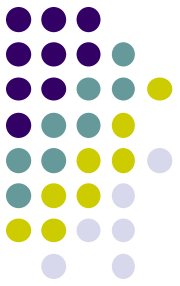

- You must keep the car key taken off from the car while you work this and finally, connect power of the interface.
- When to connect the interface cable, you must keep the power cable taken off.
- You must work this at the environment without any static electricity or damages.
- All of process on this installation should be done by professionals.
- You must not break the labels attached on the board, if it's broken, no warranty.
- When you receive this package you have to check whether there's any parts not included and you have to contact us right away.
- Our repair service do not accept any problems caused by user's any fault or carelessness.

-Main Specification

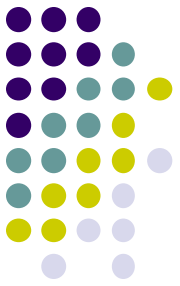

1. Input Spec. (MULTI VIDEO INTERFACE)

- 2 x CVBS Input (External video source).
- 1 x CVBS (REAR CAMERA) Input (Rear camera source)
- 1 x Analog RGB Input (Car commander original monitor output)
- 1 x Analog RGB Input (Navigation System output)->OPTION

2. Output Spec.

- 1 x CVBS OUTPUT (Video Out for installing Headrest monitor)
- 1 x RGB OUTPUT(LCD Operation)
- 1 x Audio Select OUTPUT (For operating A/V sources – ex) 12V is come out on V1 port, when AV1 is chosen.)

3. Power Spec.

- Input Power : 8VDC ~ 24VDC
- Consumption Power : 5WATT, Max

4. Switch Input mode

- NAVI/CVBS1,2 Original MUTE Function : Possible to mute each input by operating Dip S/W
- Possible to switch Input mode with remote control or toggle switch.
- Rear View Camera mode : When to sense rear gear power, be switched to Rear view camera mode (Impossible to switch to rear mode with Toggle S/W or the Remote control)

5. Special Function

- Remote Key scanning function (Option – If you want to use this function, you have to purchase the remote additionally.)

* How to use?

Press 4291 buttons of Remote offered, then LED lamp of interface blinks. After that, press any button of A/V source remote such as Navigation, DVD etc. that you want to use. If LED lamp of the interface blinks slowly, It means to succeed and you can use the button that you set for mode change.

-System Composition Map

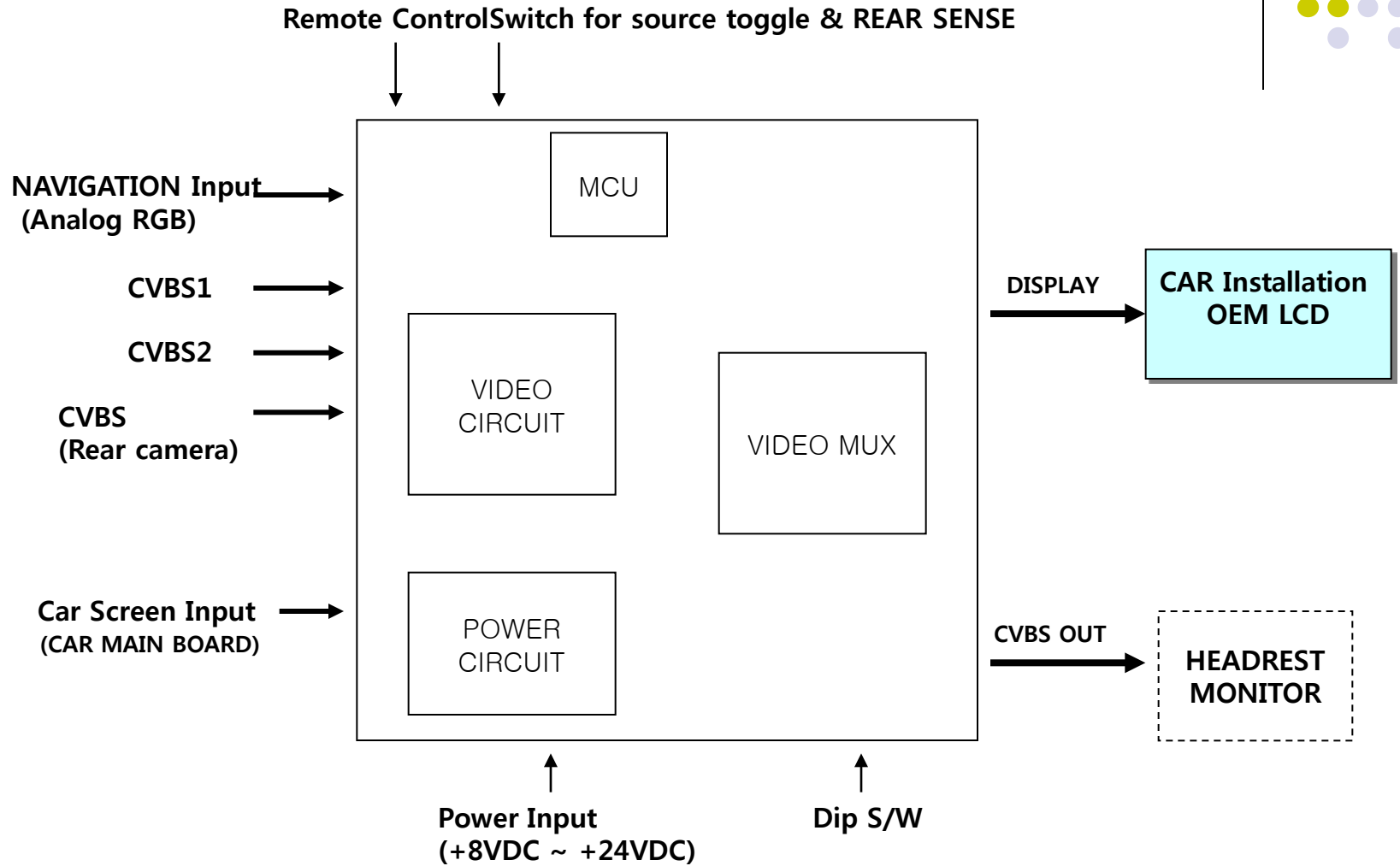
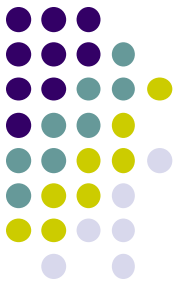

-Out-Line Dimension

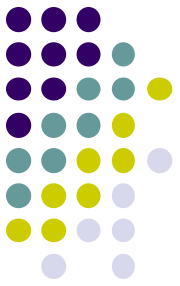

129mm * 75mm * 21mm

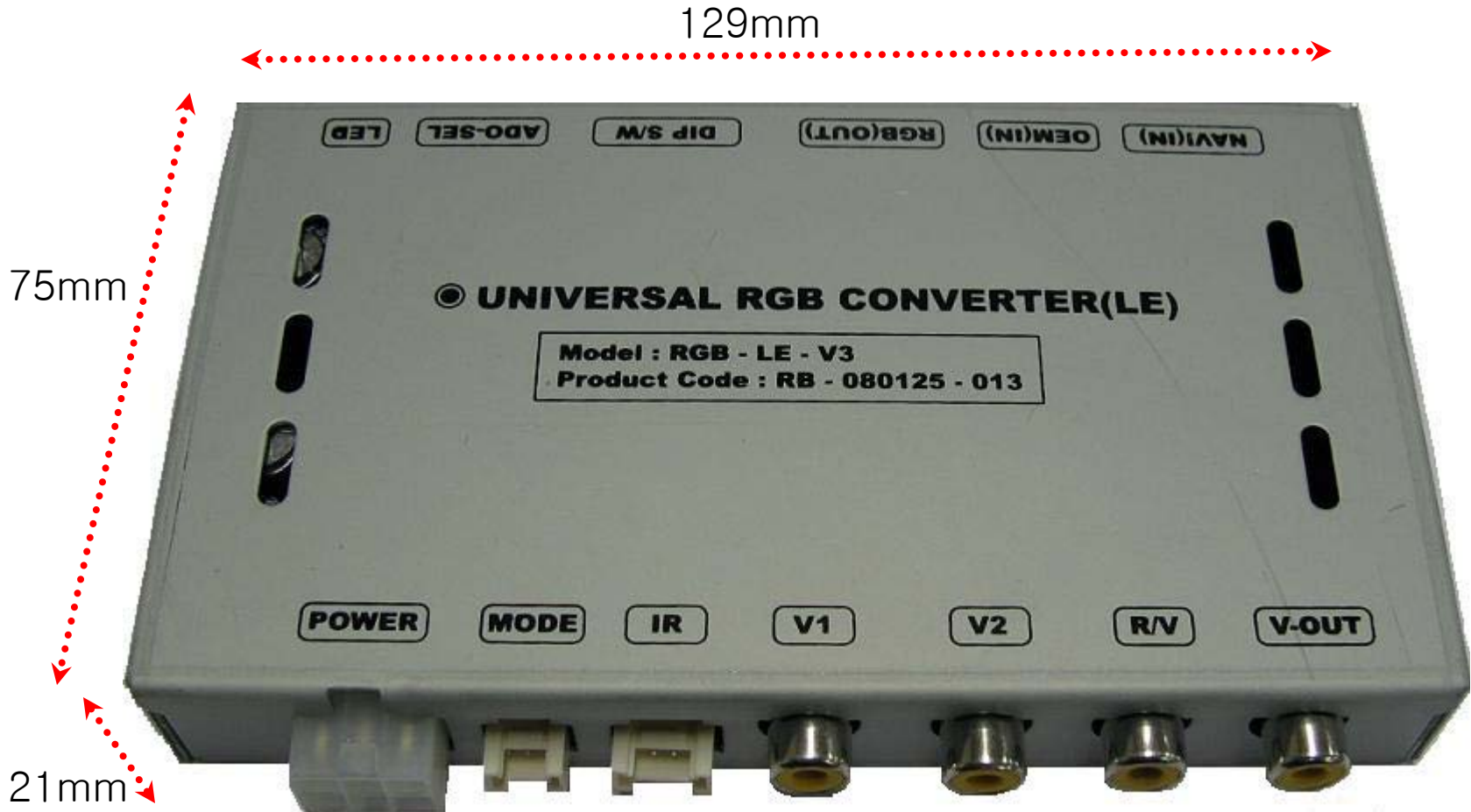

※ This can change under manufacturer's circumstance

-Module External

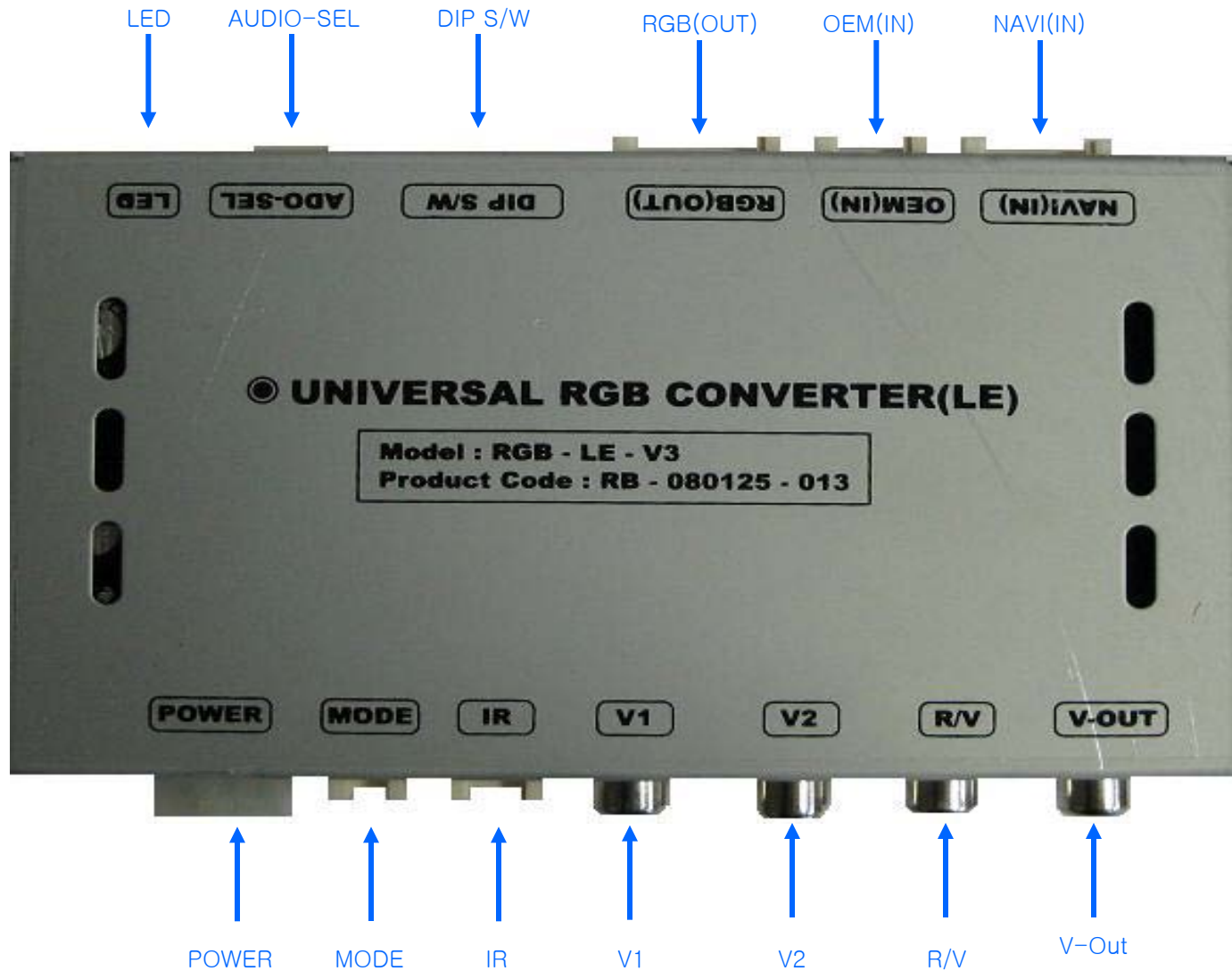
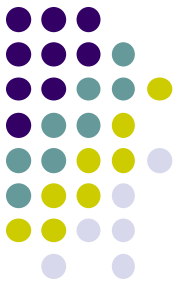

※ This can change under manufacturer's circumstance

-Module External

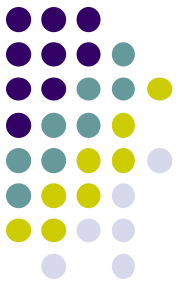

NAVI(IN)



OEM(IN)



RGB(OUT)



DIP S/W



ADO-SEL

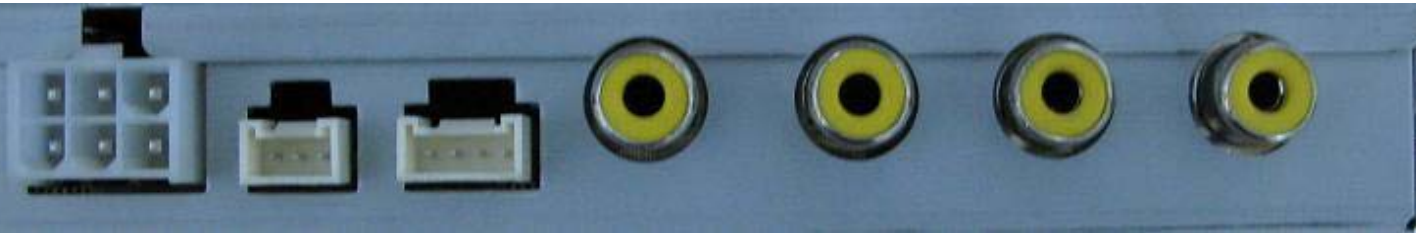
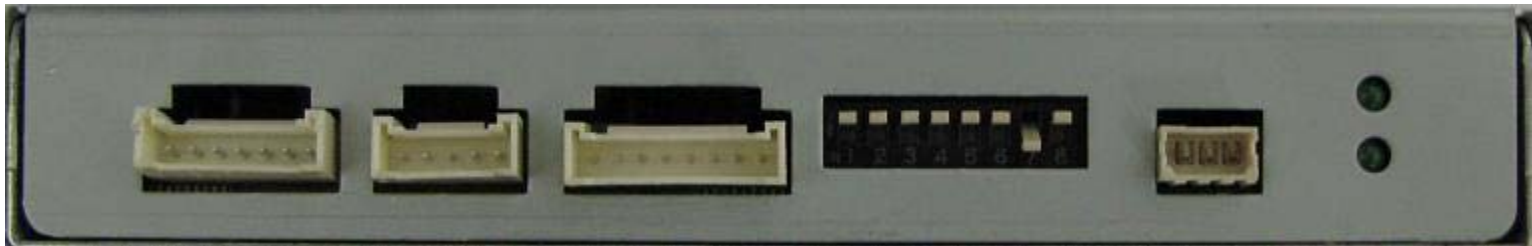

POWER

MODE

IR

V1

V2

R/V

V-OUT

※ This can change under manufacturer's circumstance

-Connector Pin Assignment

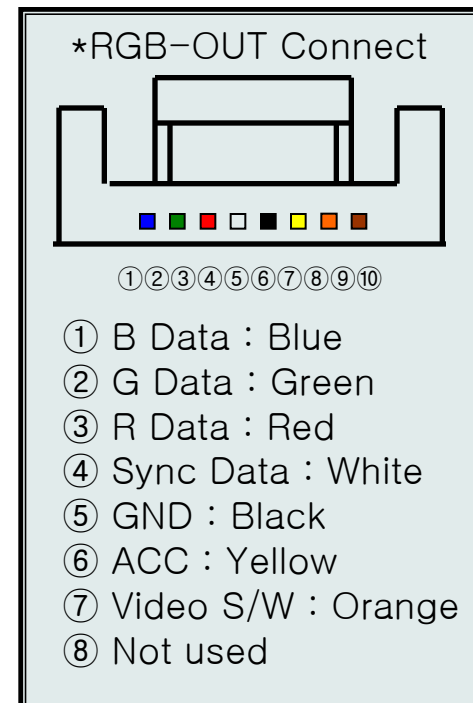
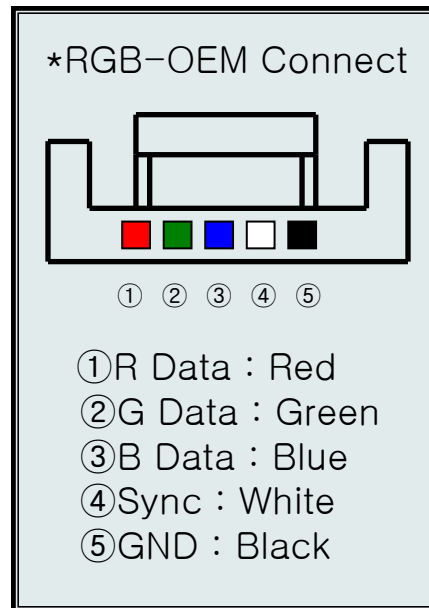
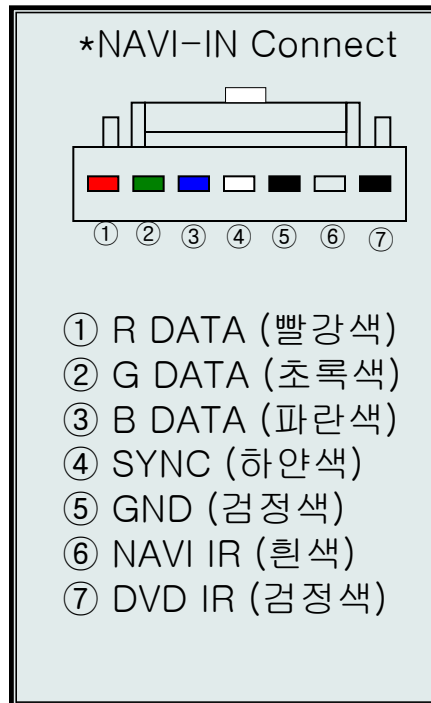
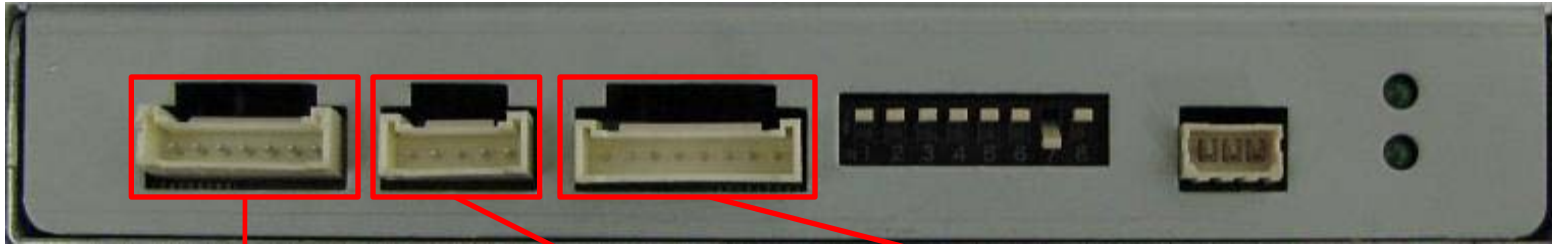
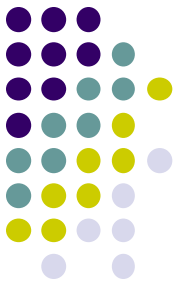

※ This can change under manufacturer's circumstance

-Connector Pin Assignment

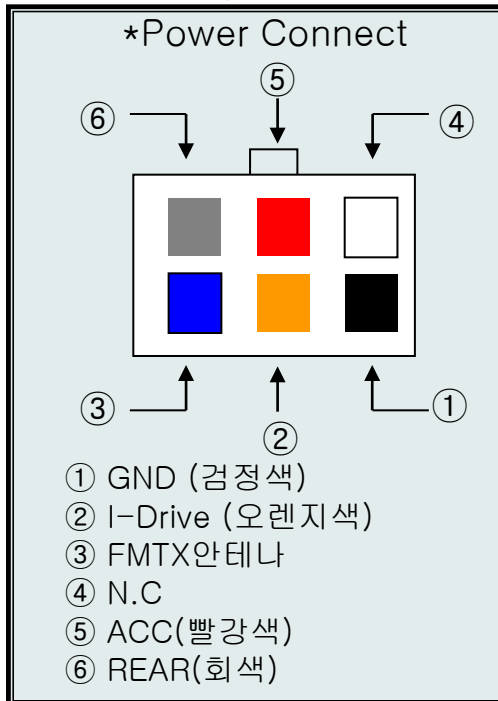
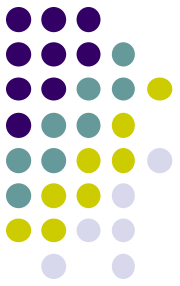

※ This can change under manufacturer's circumstance

-Connector Pin Assignment

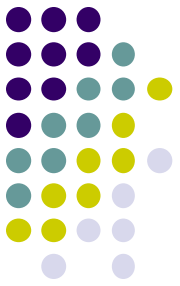

* Power cable

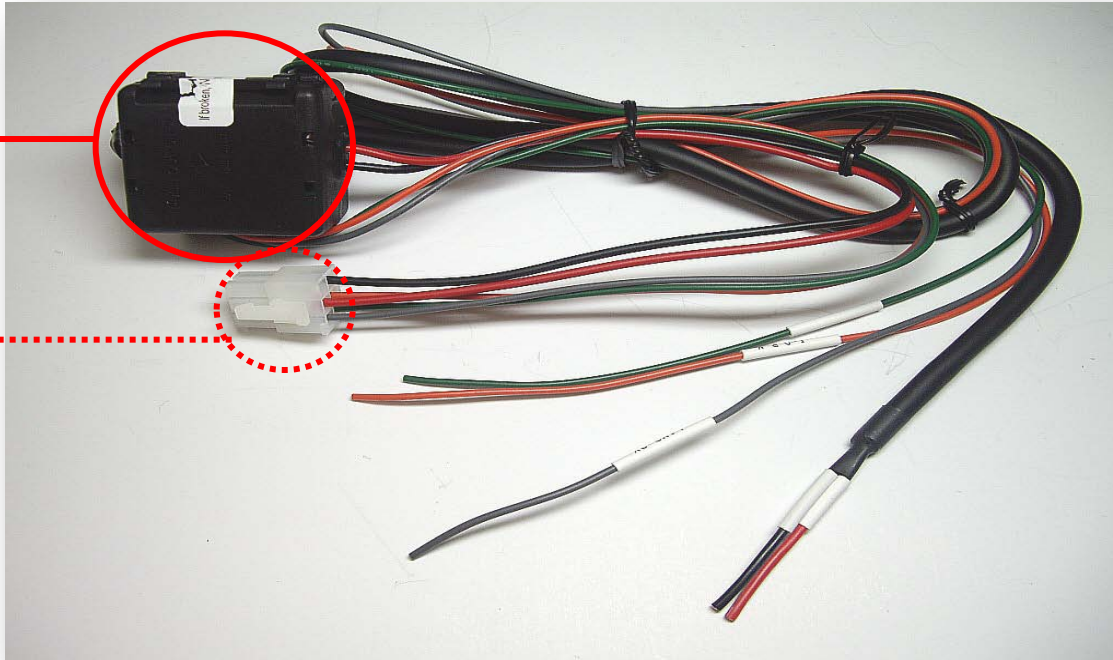

FILTER
& FUSE BOX

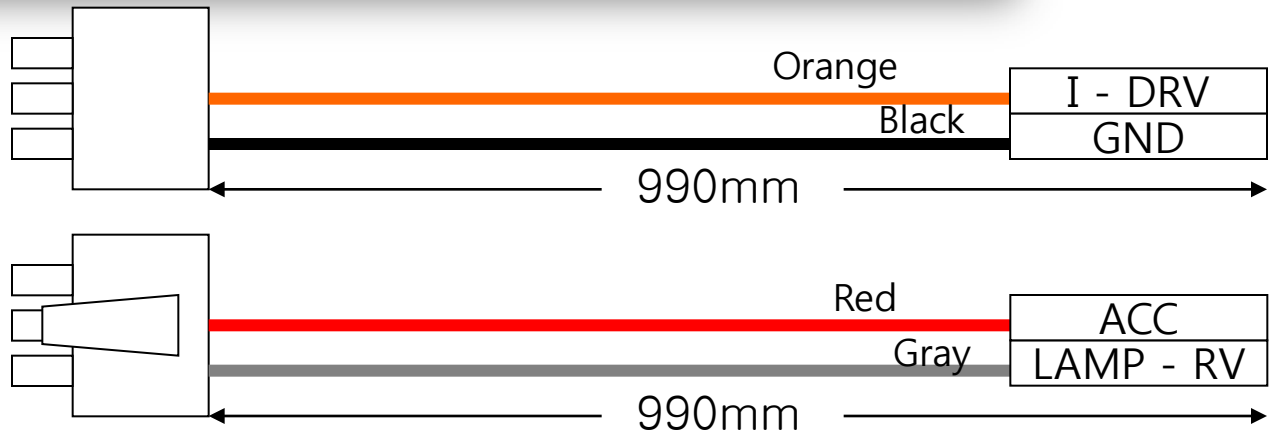
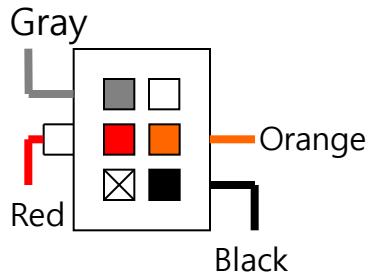

-DIP SW Operation Process

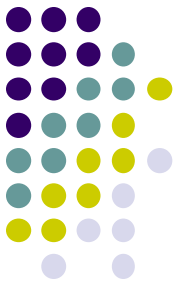

※ ON : DOWN, OFF : UP

※DIP S/W Use Example

[W211]

- . Use Input Mode : CVBS1, Navigation (RGB), Main
- . Rear Camera : When to be installed on CVBS 4

- ▷ DIP S/W : 1 → OFF
- ▷ DIP S/W : 2 → OFF
- ▷ DIP S/W : 3 → ON
- ▷ DIP S/W : 4 → OFF (All of the Car except Cayenne)
- ▷ DIP S/W : 5 → OFF
- ▷ DIP S/W : 6 → OFF
- ▷ DIP S/W : 7 → ON (enable CVBS4)
- ▷ DIP S/W : 8 → OFF

#PIN	FUNCTION	DIP S/W Selection
1	RGB INPUT MUTE	ON : Skipping RGB Mode OFF : RGB Display
2	CVBS1 MUTE	ON : Skipping CVBS1 OFF : CVBS1 Display
3	CVBS2 MUTE	ON : Skipping CVBS2 OFF : CVBS2 Display
4	CAN	ON : When install to the Cayenne OFF : When install to all of the car
5	OEM MUTE	ON : Skipping OEM OFF : OEM Display
6	INTERLACE	ON : Non-Interlace OFF : Interlace
7	REAR MODE	ON : External Rear Camera OFF : OEM Rear Camera
8	SYNC ON GREEN	ON : Sync On Green (RGSB) OFF : Sync On Green Off



*** Caution**

- If the displayed screen vibrates, please try to operate Dip S/W No. 6 after turning power off.

-Remote control

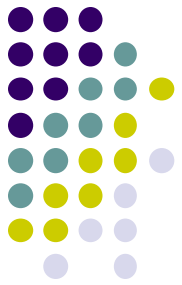

85 * 40 * 8 (mm)



- POWER : N.C
- PIP : N.C
- MENU : Activate OSD Menu
- OK : Select
- ▲ : Up
- ▼ : Down
- ◀ : Left
- ▶ : Right

-Products composition

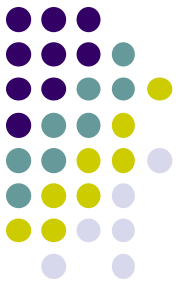

Power cable : 1

Mode cable : 1

RGB(Out) cable : 1

RGB OEM : 1

Audio Select Cable: 1

RGB NAVI : 1

IR Cable : 1

Remote Control : 1

-Installation manual

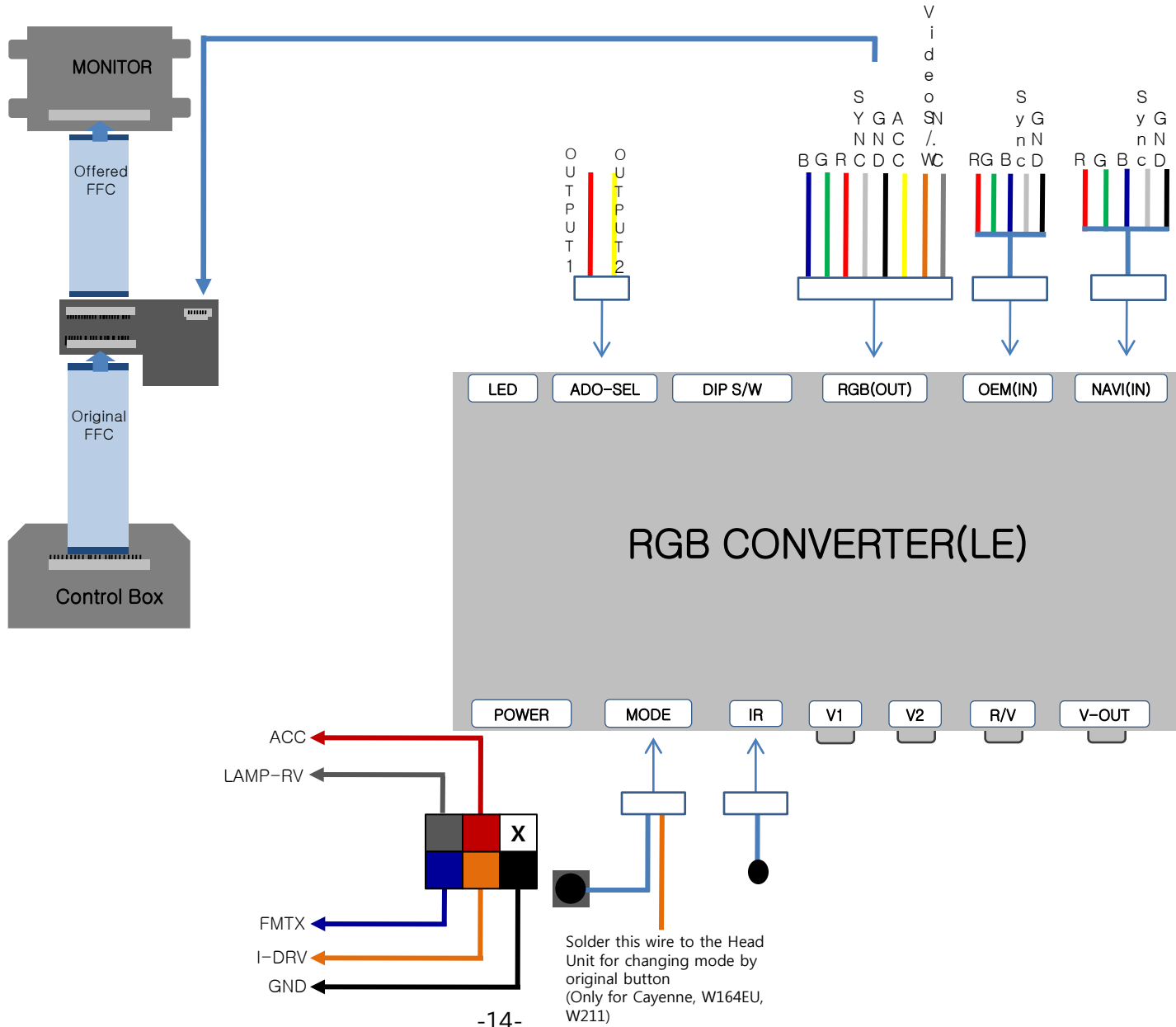

-Soldering point



©Solder the Orange wire on Mode cable to the Head Unit like picture

Soldering position: Fifth Point from right
Original button : NAVI

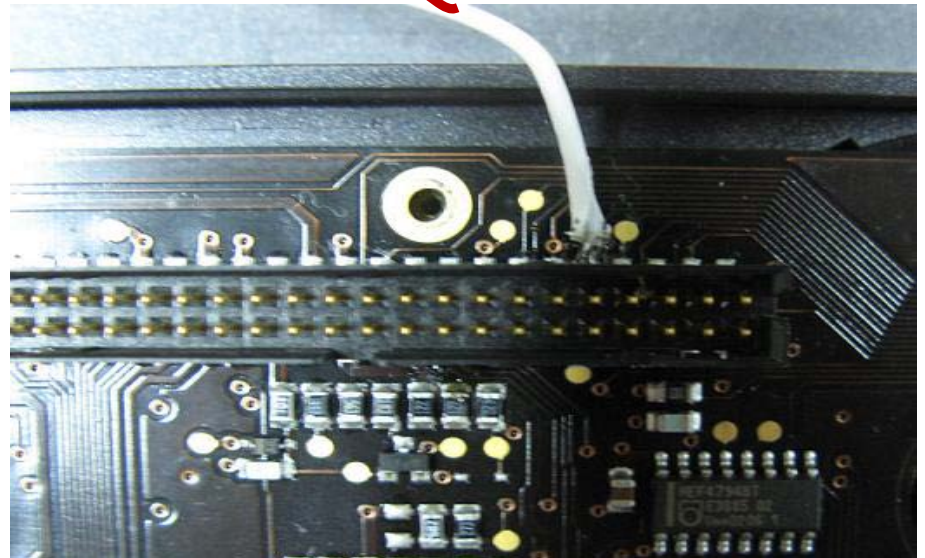

-FAQ

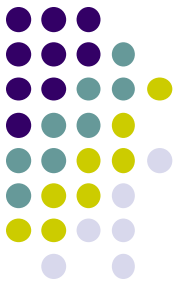

1. When can not change mode.
 - Check if the IR Cable (remote control) is connected or not.
 - Check if LED is turned on or not. If it is not turned on, Check if power cable is connected or not.
2. When the screen is displaying only black color.
 - Check if 2nd LED is turned on or not. If it is not turned on, please check the sources that you will connect with the interface is operating well or not.
 - Check if interface is connected well.
3. When displayed color of screen is not proper. (If it's too dark or the color is not proper)
 - Try to push "Reset button" on the remote control. If the color of screen keeps on displaying wrong color, you have to ask manufacturer for the problem.
4. When Back-up camera is not displayed on the screen.
 - Turn Dip S/W no.7 on.
5. When the mode you set is not skip.
 - Check if Dip S/W is set in proper way.
6. When Main screen on the car is not displayed.
 - Check if In/Out cables are connected well. If it keeps showing the same problem, you have to ask manufacturer for the problem.
7. When the screen is displaying only white color.
 - Check if out cable is connected well. If it keeps showing the same problem, you have to ask manufacturer for the problem.
8. The case the screen is changed to Main mode despite of choosing Back-up camera mode.
 - Check if Dip S/W no.7 is turned on. If it's not, you have to turn it on.
9. When the screen is blinking or not proper.
 - Turn Dip S/W no.6 on.