

Mercedes09 interface installation manual

This interface can insert RGB/composite video into Mercedes 09 version monitors [Monitor with SD card slot]. So RGB navi map or reverse camera video or TV/DVD changer image can be displayed.

All the installation process is plug-and-play.



Composite video display



High resolution RGB-NTSC display

Note: the pictures below are Mercedes E/ML car monitors. This interface can be also used for E/CLK/GL/ML Mercedes cars[with SD card].

This interface box is made up of two parts, **external box** and **internal daughter board**. The internal daughter board should be inserted onto the 60P ribbon cable to monitor, while the external box is located outside the monitor. One 50P cable is used to connect these 2 parts.

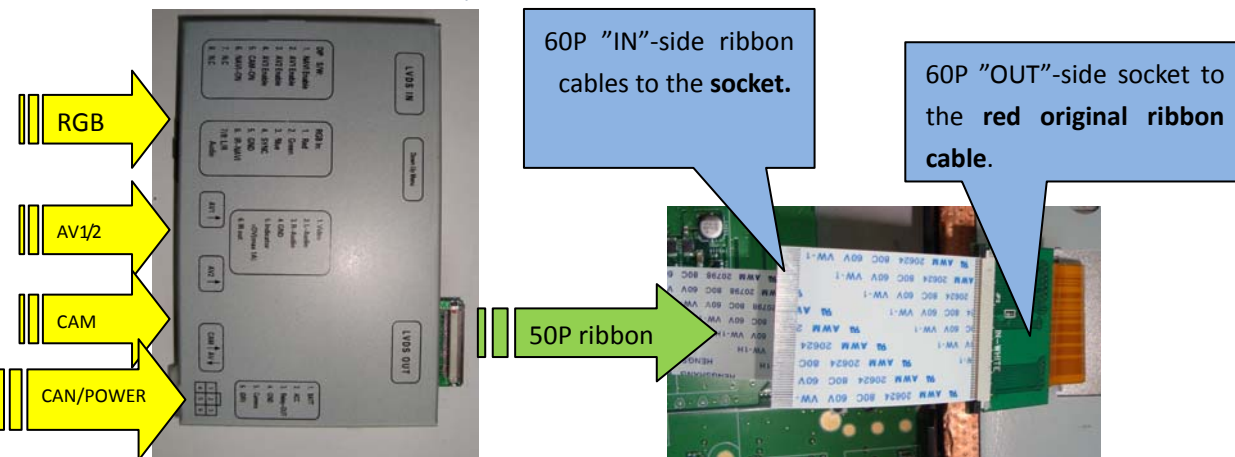

Installation:

- (1) Take the monitor out from the car. For W211/220 cars, only necessary to remove the plastic with hooks, the monitor can be taken down, on screws usually.
- (2) Open the monitor's panel side in this way:

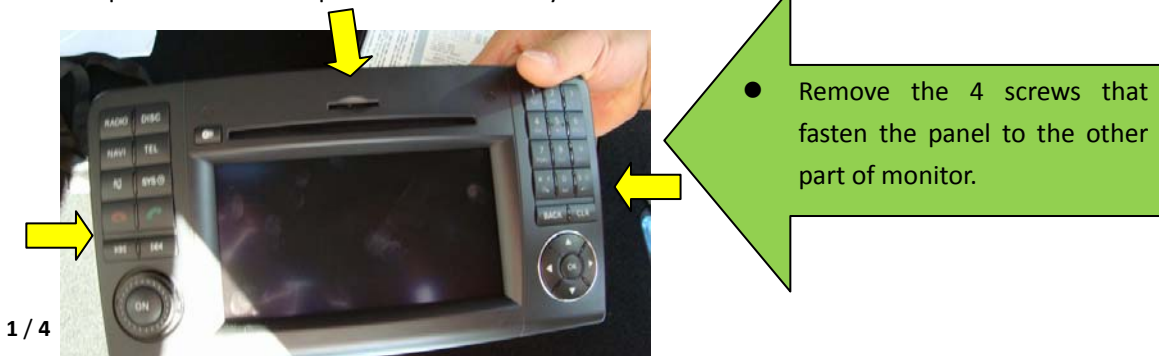

● Then remove the big aluminum part

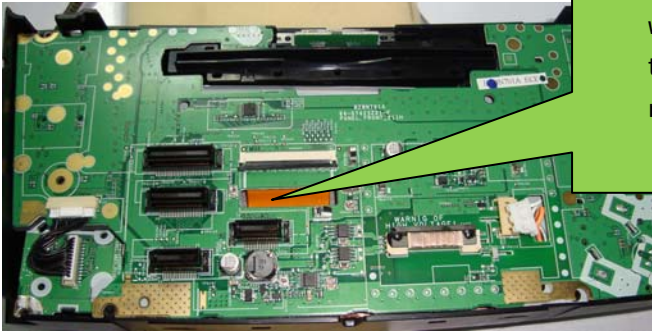
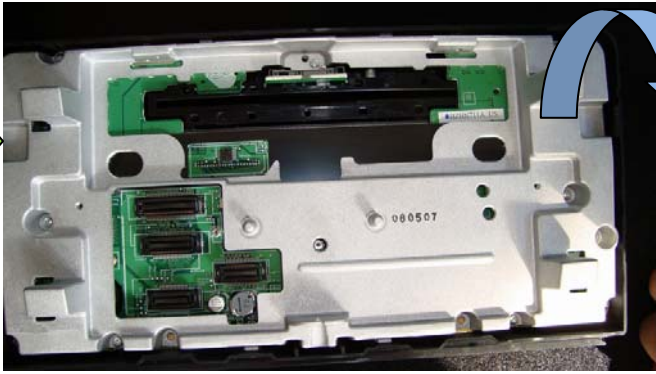

● Then a 60P white socket inserted with RED ribbon cable can be seen, the interface is inserted between this ribbon cable and socket.

Take away the PCB, then the LCD panel can be seen in this way, the Gray metal part should be removed so that the small PCB can be located in its location.

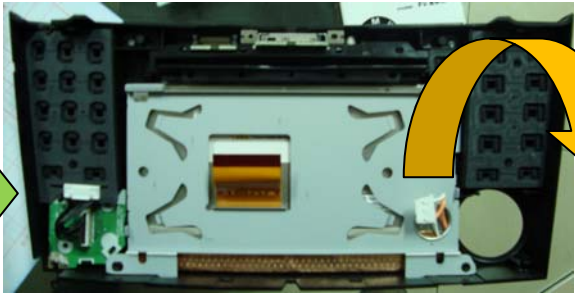

(3) Install the daughter board and box:

The Daughter board has already 2 white-ribbon cable:

- The 5CM 60P ribbon should be connected to the PCB's 60P socket.
- The 50P long ribbon should go out to the external box.
- The 60P socket marked with "OUT-RED" is for the 60P red panel ribbon.

Then the total is like this picture→
Then put the PCB, the aluminum shell back.

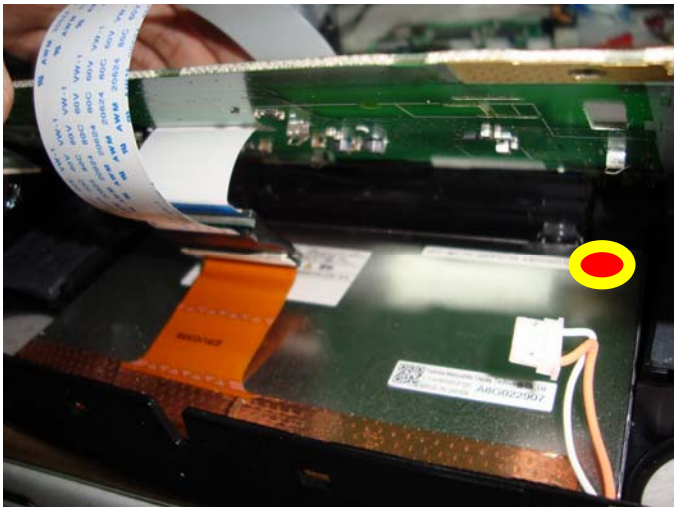

50P ribbon should go out from the “Downside” of the monitor, otherwise it will conflict with the CD-ejecting slot.

The other side of the ribbon should be inserted into the interface box.

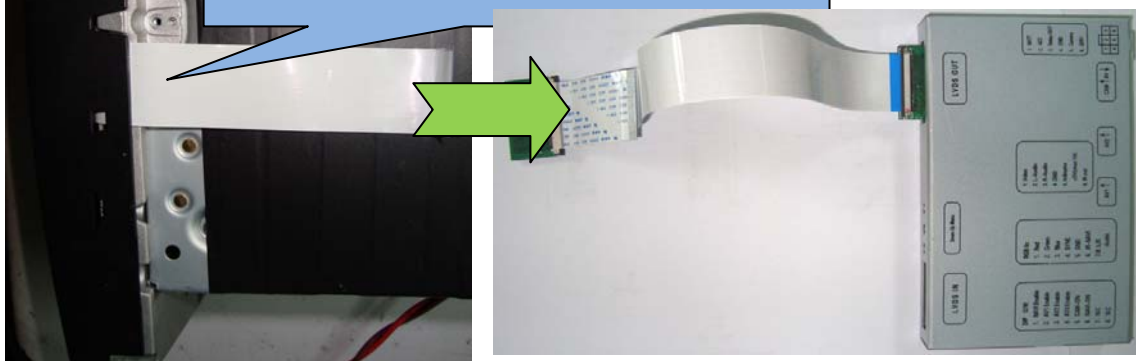

Finally, the total box should be wrapped firmly onto the monitor or chassis or other part inside the car dash board.

[Be sure the fan is not blocked by glue type when fixing onto monitor]



The aluminum has a hook which may conflict with the 50P cable, cut that hook off.

(4) DIP SETTING:



DIP	ON-location	OFF---location
1	RGB enabled	RGB disable
2,3	AV1/2 enabled	AV1/2 disable
4		
5	When reverse[Green wire =12V]: go to AV4	When reverse[Green wire =12V]: go to Original video
6		
7		
8		

INPUT switch

There are 2 ways to switch the input

- With the CAN BOX, press the “hang-off” on the steering wheel.
- The user may also use the extra small keypad→ .



CAN Connection:



The CAN box will decode the CAN data, and generate the ACC, switch-signal for the interface.

The ACC can be used for extra devices like reverse camera and TV tuner. The interface box itself does not use ACC, it will power on/off automatically when the monitor turn on/off.

[CAN box wrong connection will not damage or hurt any device, when correctly connected, the LED will be blinking with data.]

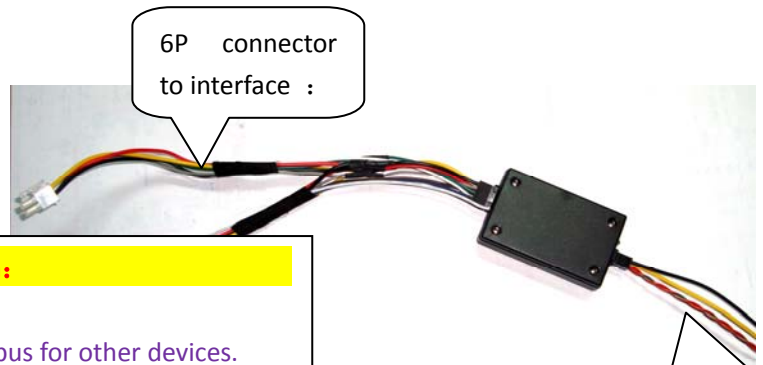

6P signal definition:

- YELLOW:** BATTERY 12V.
- RED:** ACC generated from the CAN bus for other devices.
- BLACK:** Ground for chassis.
- GREEN:** reverse signal lien[=12V when reverse], should be connected to rear lamp.
- WHITE:** switch signal, when >3V, the interface switches the input.[max.25V]
- GRAY:** no function.

CAN inputs: CAN+, CAN-, BATT, GND

Accessories:

- (1) [] One interface box
- (2) [] one CAN box with power cable.
- (3) [] one daughter board with 50P other-side ribbon, 60P same-side ribbon
- (4) [] AV input wire 2PCs, CAM wire 1PC, RGB wire 1 PCs.
- (5) [] keypad 1 PC.