

BENZ SPECIFICATION

(W221, W204, W212)

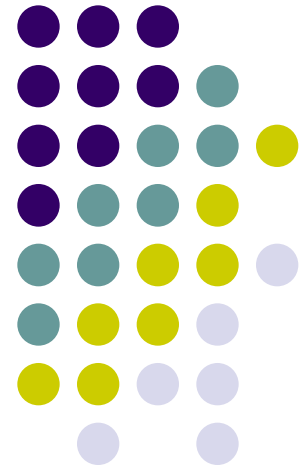

- . MODEL: QVL-MB08-STD-V6.5
- . Product Code : QV-NS-0904-902



Index

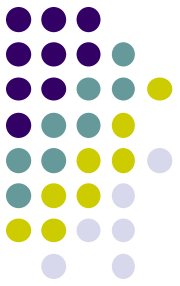

-.	Updated points on this version	3
-.	Precaution	4
-.	Main Spec.	5
-.	Switching Mode through CAN	6
-.	CAN Wiring	7
-.	System Composition	8
-.	Outline Dimension	9
-.	External Appearance	10
-.	Connector Pin Assignment	12
-.	DIP Switch Setting	14
-.	How to use Remote control	16
-.	OSD (On Screen Display)	17
-.	FMTX Frequency Setting	22
-.	How to use parking guide line	23
-.	Product Composition	25
-.	Installation Structure	26
-.	Installation Guide	27
-.	FAQ	33

Updated points on this version



- More convenience to install with plug & play (LVDS cable offered)
- Possible to move the displayed position of DVD, Navi
- Changed OSD MENU
- Possible to choose NAVI model (WQVGA, WVGA)
- S-Class(W221 8"), C-Class(W204 4", 7"), E-Class(W212 5.8", 7")
- Offer sub-board for stability

Precaution

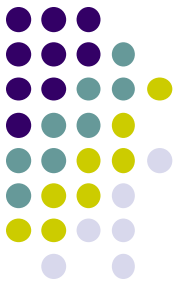

- You must keep the car key taken off from the car while you work this and finally, connect power of the interface.
- When to connect the interface cable, you must keep the power cable taken off.
- You must work this at the environment without any static electricity or damages.
- All of process on this installation should be done by professionals.
- You must not break the labels attached on the board, if it's broken, no warranty.
- When you receive this package you have to check whether there's any parts not included and you have to contact us right away.
- Our repair service do not accept any problems caused by user's any fault or carelessness.

Main Spec.

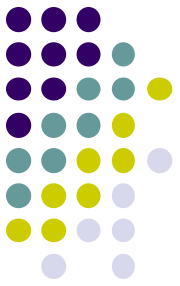

1. Input Spec. (MULTI VIDEO INTERFACE)

- 1 x Analog R,G,B (Sync on Green)
- 1 x CVBS(NTST & PAL Auto Detect) Input. (Rear camera source)
- 3 x CVBS(NTST & PAL Auto Detect) Input. (A/V source)
- 1 x LCD Input (Car system Input)

* **W221, W204 7" : Support NTSC/PAL, W204 5" only support PAL**

2. Output Spec.

- 1 x CVBS OUTPUT (Video Out for installing Headrest monitor)
- 1 x Audio OUTPUT
- 1 x LCD OUTPUT(LCD Operation)

3. Power Spec.

- Input Power : 18V
- Consumption Power : 12WATT, Max

4. Switching Mode (AV source)

- Possible to skip AV source while switching Mode (AV source) by DIP S/W (Refer to the DIP S/W page)
- By 'SET' button of the Remote
- By Toggle Switch (Option)
- By Original button of the car through CAN
 - W221(8") : NAVI Button
 - W204(7", 4"), W212(7") : Return Button
 - W212(5.8", 7") : Return Button

Switching Mode through CAN



After wiring CAN of the car with offered CAN cable, you can switch A/V mode by the Factory button as below. Refer to the next page for wiring)



For W221(NEW S-Class) :
Switching Mode by "Navi/Tel" Button like the left picture



For W204 7 inch, 5 inch (C-Class), W212 (E-Class) :
Switching Mode by Return Button like the left picture

※ In W204 7 inch 's case, the button is written "Return"

CAN Wiring

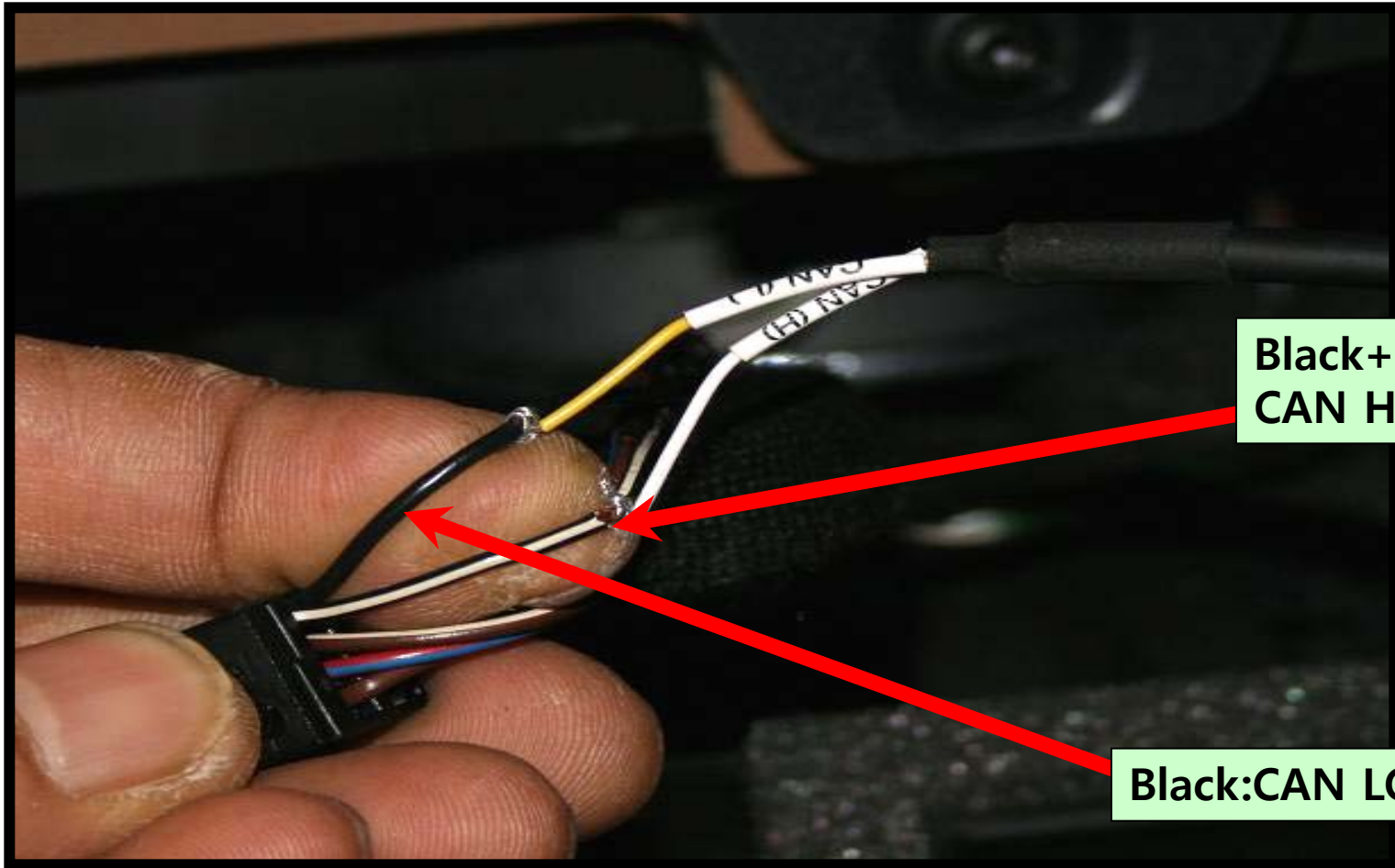
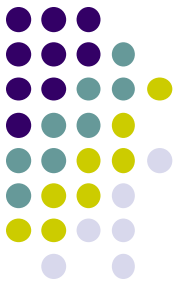

**Black+White:
CAN HIGH(White)**

Black:CAN LOW(Yellow)

- Connect the white wire of CAN cable offered to black+white wire of the car, the yellow wire to black wire of the car like the above picture.
- You should connect the original CAN wire which is behind the monitor

* The color of CAN wires coming from the car can be different by each countries that the car import or any other circumstances.

System Composition

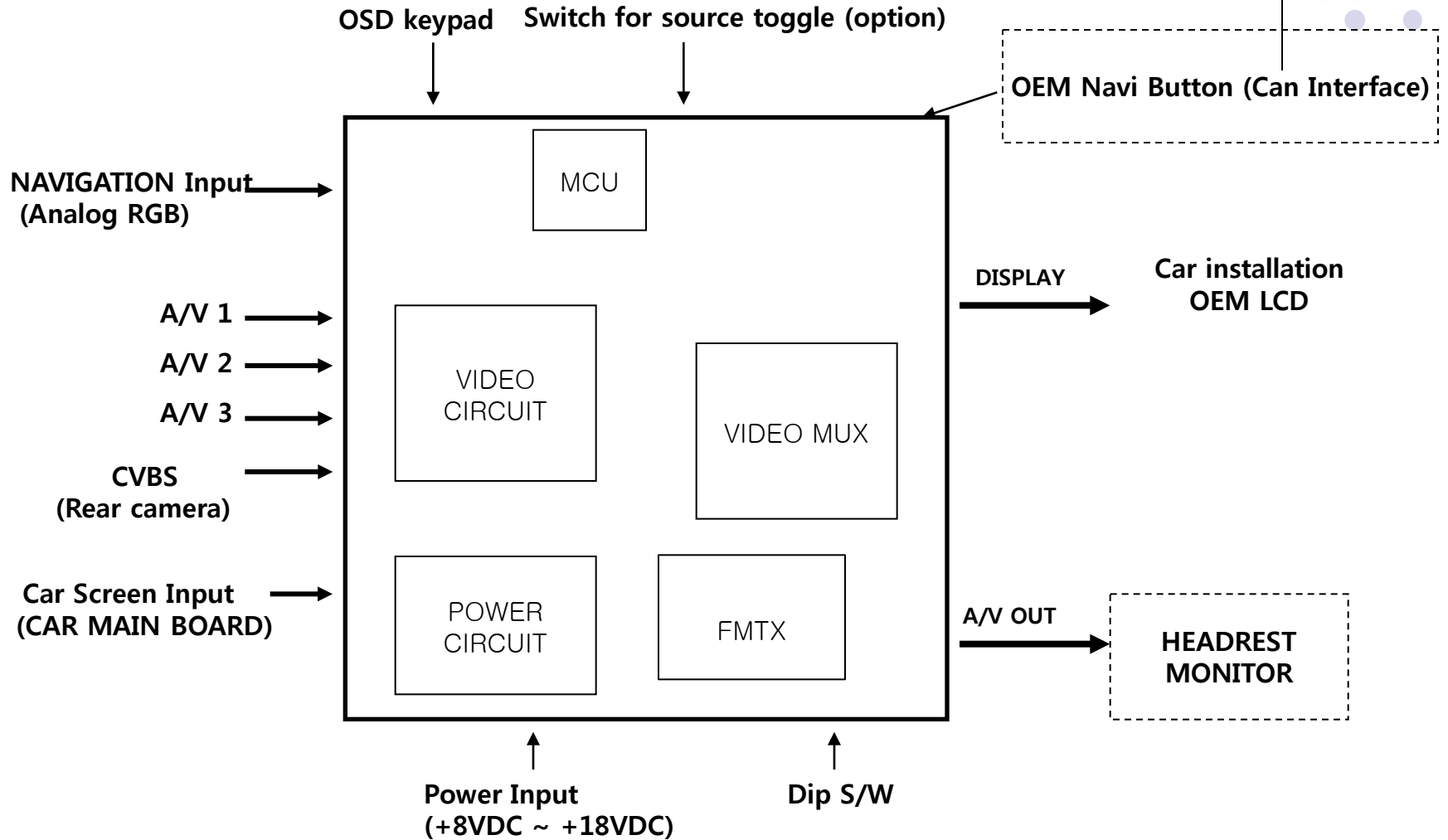

Outline Dimension

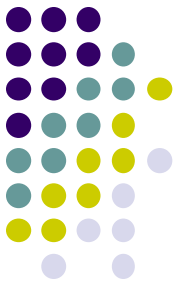

153mm * 90mm * 22mm



External Appearance

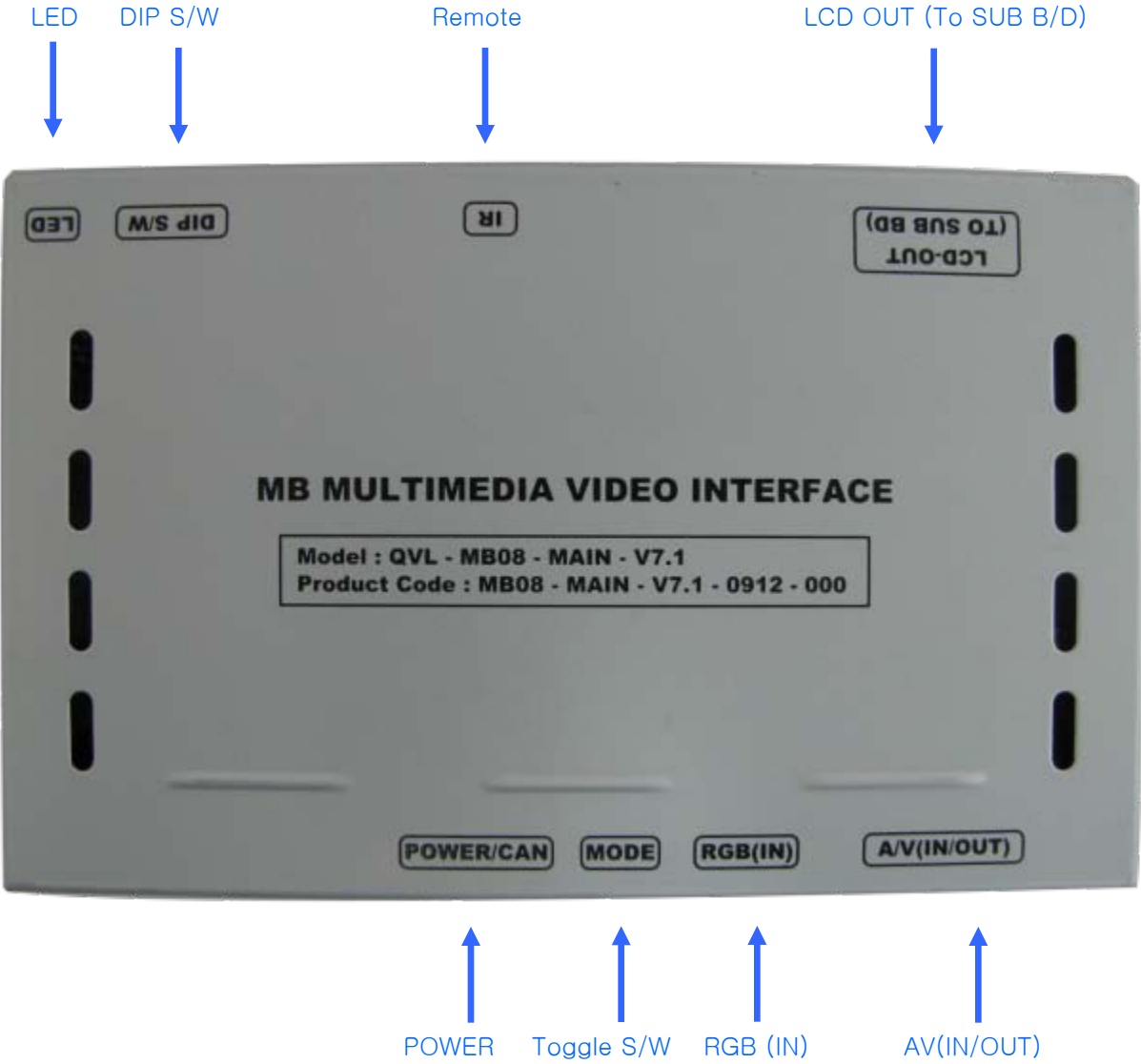

External Appearance



↑
POWER Toggle S/W RGB(IN) AV(IN/OUT)



↑
LCD-OUT Remote Control DIP S/W LED

Connector Pin Assignment

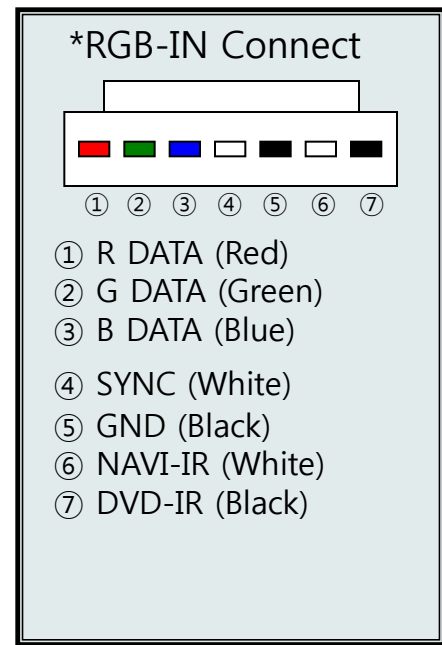
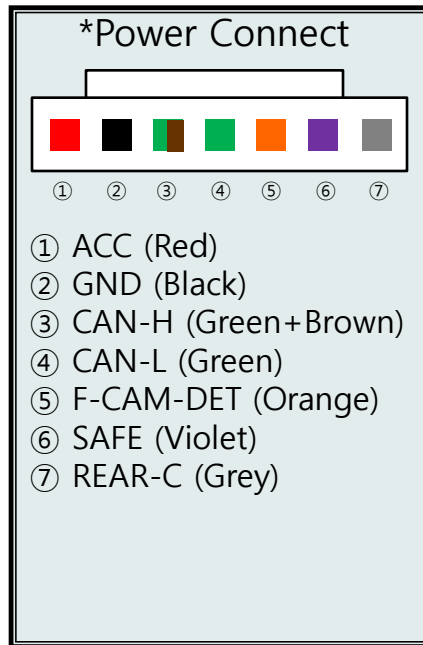
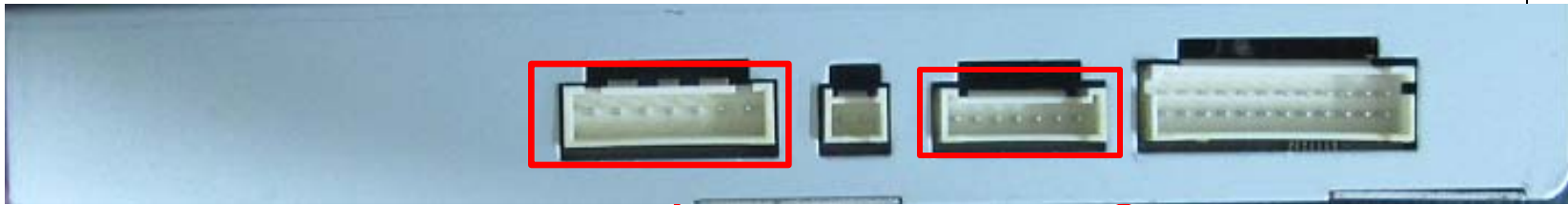
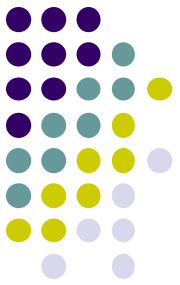

※ F-CAM-DET : Not Used
NAVI-IR : Not Used
DVD-IR : Not Used

Connector Pin Assignment

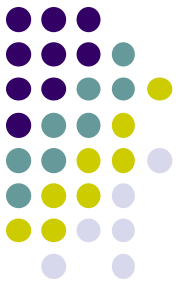

* Power Cable

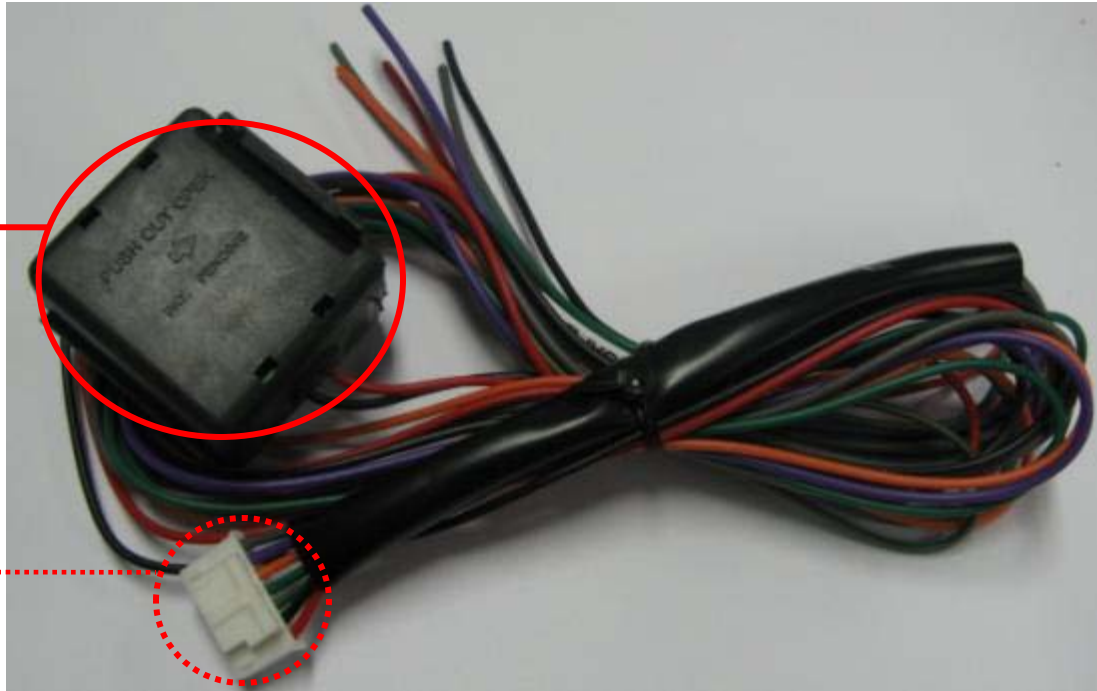

**FILTER
& FUSE BOX**

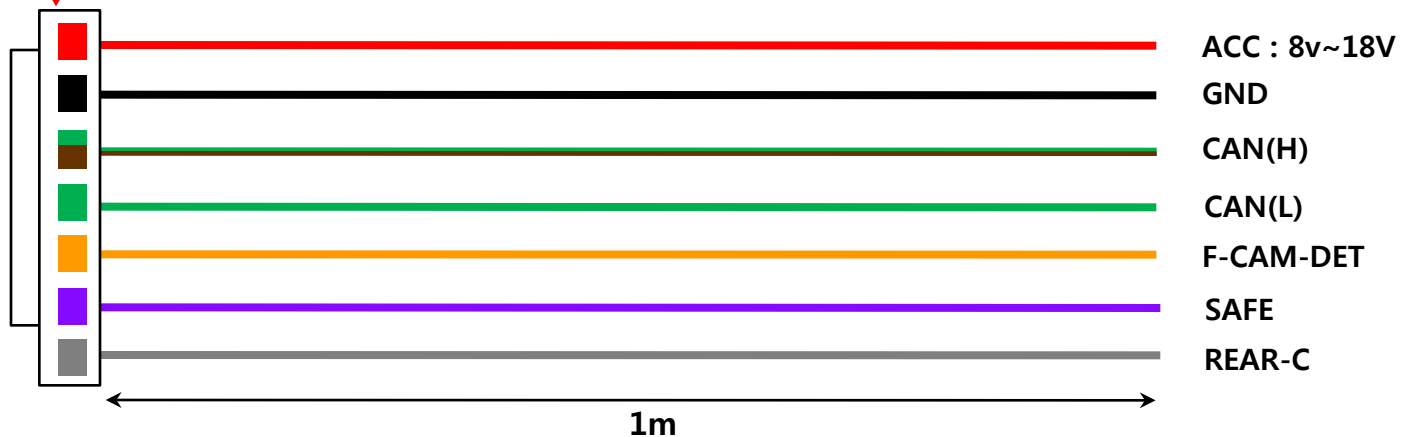

DIP S/W

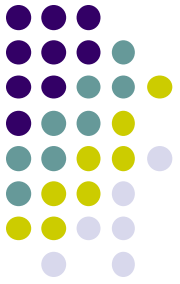

#PIN	FUNCTION	DIP S/W Selection
1	RGB INPUT MUTE	ON : Skipping RGB Mode OFF : RGB Display
2	A/V 1 MUTE	ON : Skipping A/V 1 OFF : A/V1 Display
3	A/V 2 MUTE	ON : Skipping A/V 2 OFF : A/V2 Display
4	A/V 3 MUTE	ON : Skipping A/V 3 OFF : A/V3 Display
5	Car Models	ON : NEW C-Class(W204,200,230,GLK) OFF : NEW S-Class(W221) ,New E-Class(W212)
6	To select monitor size (Only for C-Class)	ON : When to install 7Inch and W212 5.8" OFF : When to install 4Inch, GLK
7	Rear Mode	ON : External Rear Camera OFF : OEM Rear Camera
8	OEM Navi Mute	ON : In case of OEM Navi installed OFF : In case of OEM Navi not installed

※ ON : DOWN, OFF : UP

※DIP S/W Use Example

[New C-Class GLK]

- . Use Input Mode : A/V3(DVD), Navigation (RGB)
- . Rear Camera : When to be installed on CVBS 4
- . When original Navi is not installed

- ▷ DIP S/W : 1 → OFF
- ▷ DIP S/W : 2,3 → ON
(INPUT MODE SKIP)
- ▷ DIP S/W : 4 → OFF (enable A/V3)
- ▷ DIP S/W : 5 → ON (New C-Class)
- ▷ DIP S/W : 6 → ON
- ▷ DIP S/W : 7 → ON (enable CVBS4)
- ▷ DIP S/W : 8 → OFF

DIP S/W



DIP S/W Setting Guide by car model & monitor size.

-DIP S/W no.5 : Car model (For W221&W204&W212),

-DIP S/W no.6 : Monitor size (For W204, W212)



NEW S-Class(W221)

The setting like the left pic is default, this setting is for W221.

(Dip S/W no. 5, 6 should be off, when to install W221)



C-Class(W204) - 4Inch

(Dip S/W no. 5 should be on, when to install W204 5 inch.)

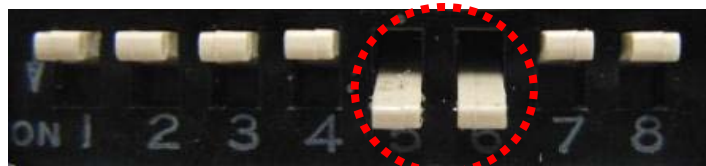

C-Class(W204) - 7Inch

(Dip S/W no. 5,6 should be on, when to install W204 7 inch)



E-Class(W212) - 5.8Inch

(Dip S/W no. 6 should be on, when to install W212 5.8 inch. Dip S/W no. should be off when to install W212 7" and set "W212" in Factory-Util-Car Model)

How to use remote

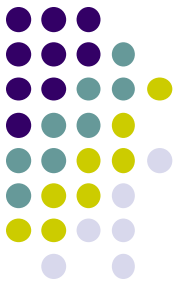

Dimension : 85 * 40 * 8 (mm)



POWER&PIP : N.C

MENU : OSD MENU

OK : Selection

▲ : Up

▼ : Down

◀ : Left

▶ : Right

*FACTORY MODE (Interface setting for **installer**)

: Operated by pressing ▲ → ▼ → ▲ → MENU or press ◀ more than 5sec of remote

OSD(On Screen Display)



• Analog RGB Mode



• Video Mode

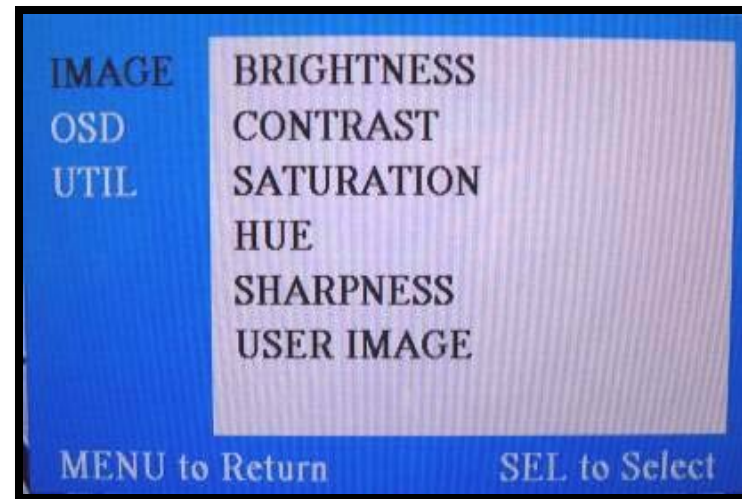
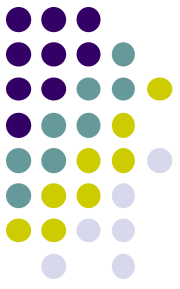

IMAGE Menu

- BRIGHTNESS: It is used to adjust brightness of the screen.
- CONTRAST: It is used to adjust distinction (Image noise clearness).
- SATURATION: Adjust the saturation the picture.
- HUE: It is used to adjust the display hue adjustment of the screen.
- SHARPNESS: Adjust the sharpen or soften the picture.
- USER IMAGE :select color of screen (only four type)

OSD(On Screen Display)



- Analog RGB Mode

- Video Mode

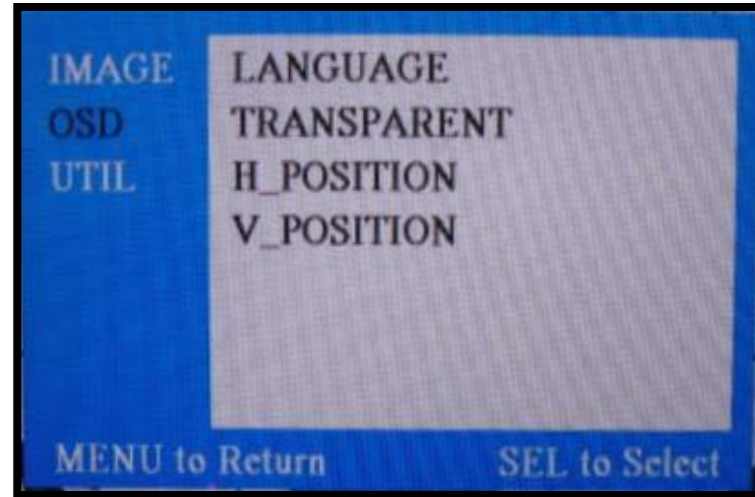
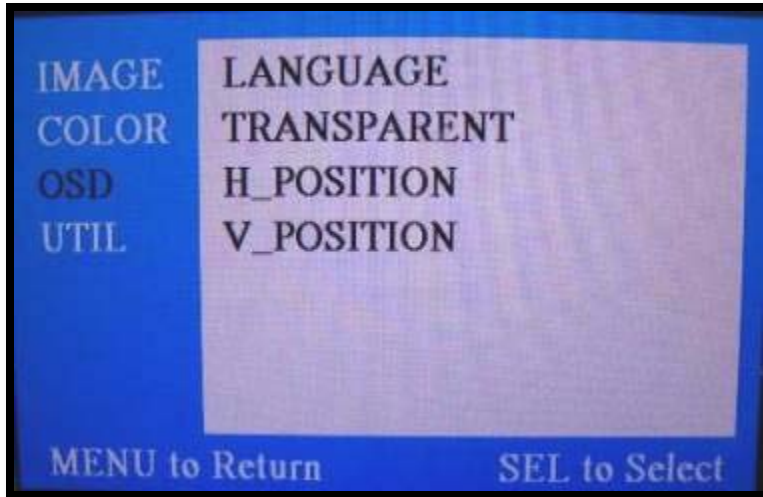

OSD Menu

- LANGUAGE: OSD language and appearance can be changed.
- TRANSPARENT: You can select the OSD background to be opaque or translucent.
- H_POSITION : Move the position of AV sources to Left, Right
- V_POSITION : Move the position of AV sources to Up, Down

OSD(On Screen Display)

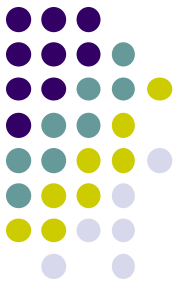

- Analog RGB Mode

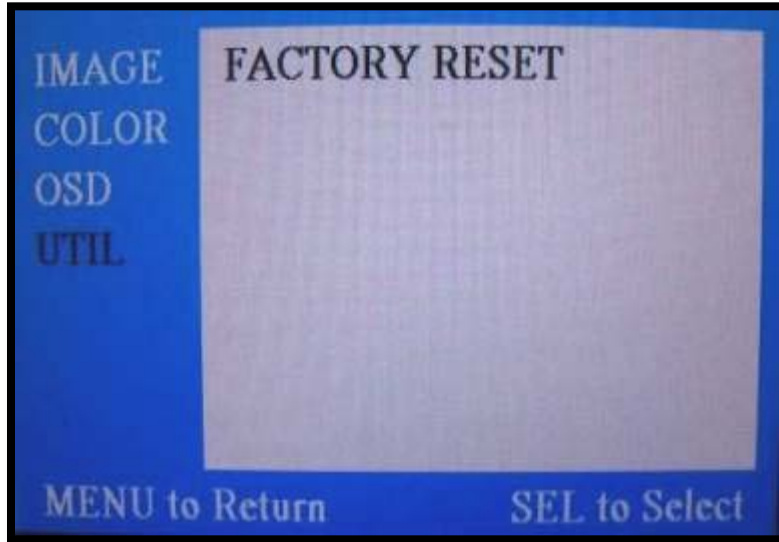

- Video Mode

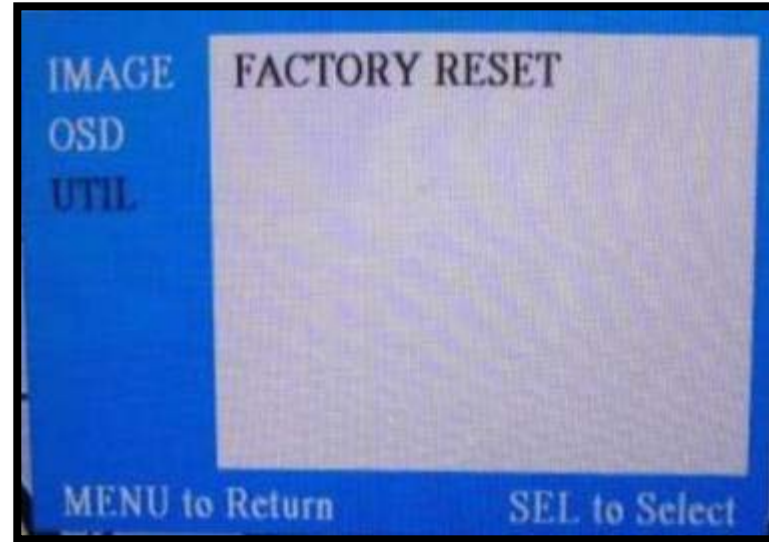

UTIL Menu

- FACTORY RESET : Initializing of all values of OSD setting
(Impossible to reset of screen position, only possible for functions in OSD)

OSD(On Screen Display)

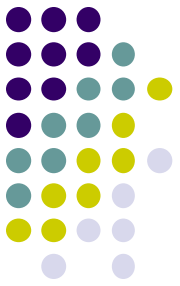

- **FACTORY Mode-** Operated with pressing UP->DOWN->UP->MENU keys of the keypad sequently.

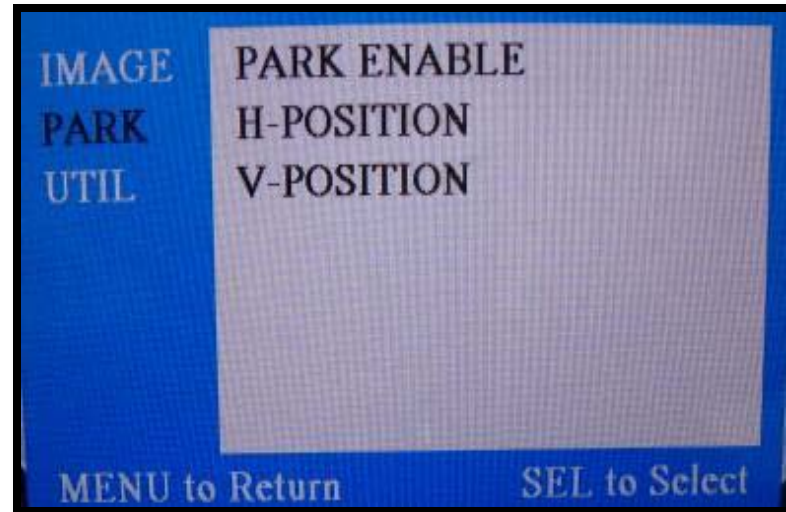
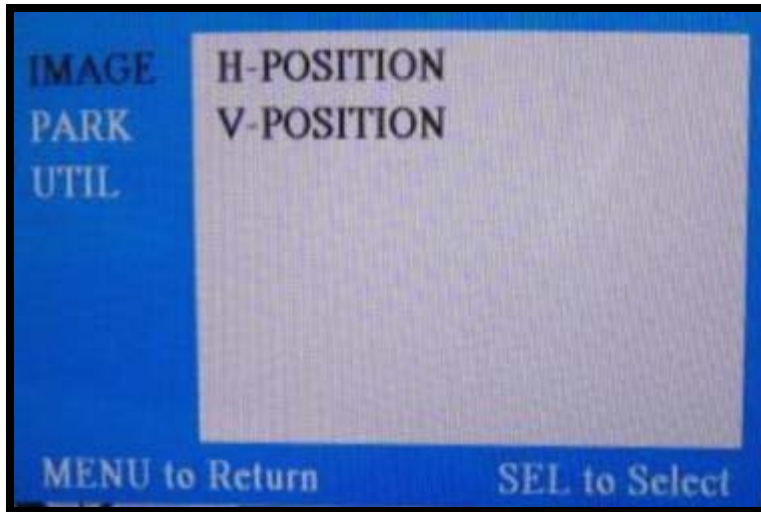

Factory Mode

- **IMAGE - H-POSITION** : Move to Left, Right
 - **V-POSITION** : Move to Up, Down
- **PARK - PARK ENABLE** : Setting to use 'Parking guide line'
 - **H-POSITION** : Move the lines to Left, Right
 - **V-POSITION** : Move the lines to Up, Down

OSD(On Screen Display)

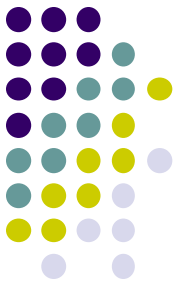

- Factory Mode

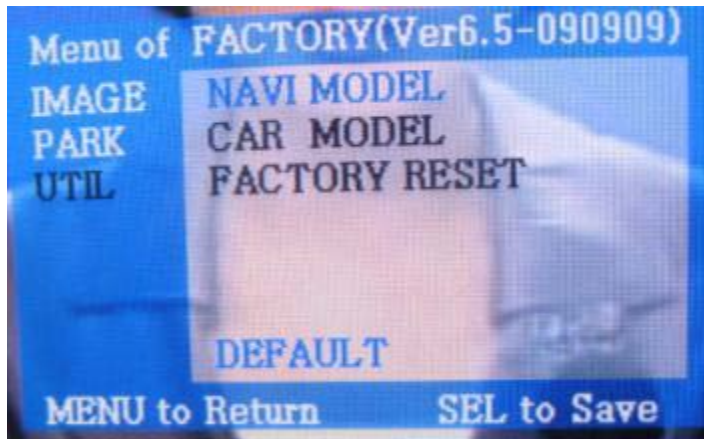

Factory Mode

- **UTIL** - NAVI MODEL : DEFAUTL – For Chinese navigation
PANSONIC – Standard

OSD(On Screen Display)

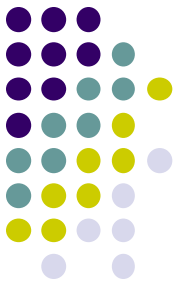

- Factory Mode

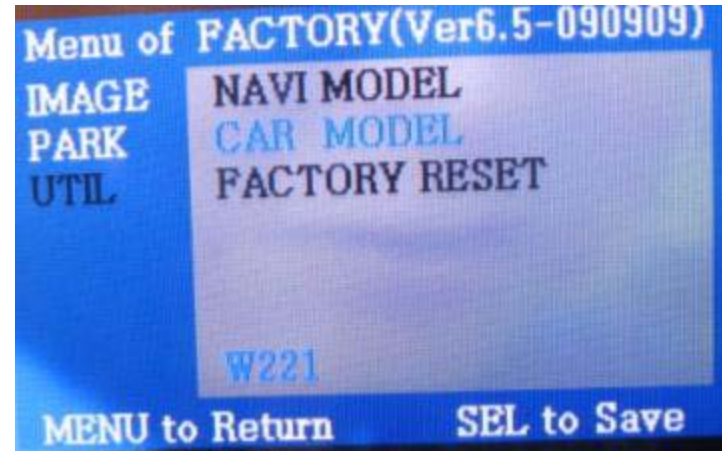
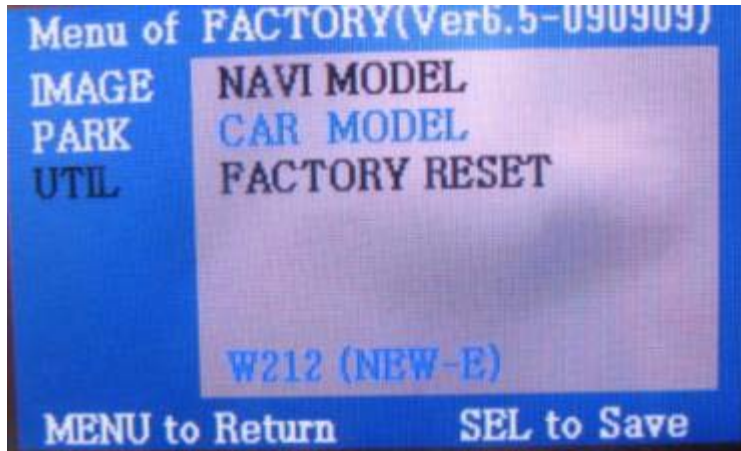

Factory Mode:

- **UTIL** - CAR MODEL : Select Car model
 - W212 (NEW-E) – For New E-Class 7"
 - W221 – For S, C-Class, New E-Class 5.8"
 - (Select S, C-Class and E-Class 5.8" by DIP S/W)
- FACTORY RESET

How to use parking guide line

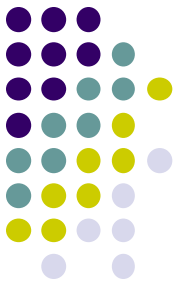

①

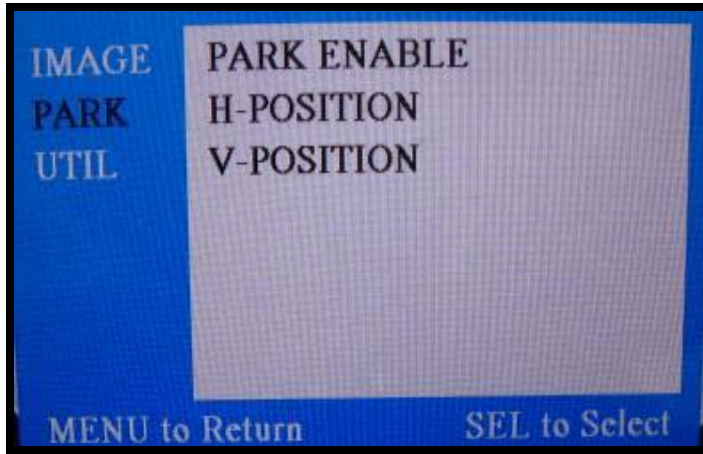

① Set "PARK ENABLE" to "ON" on The park mode like the left picture no.1

*** If you would like to remove this line, just select "ON" on the above process.**

②

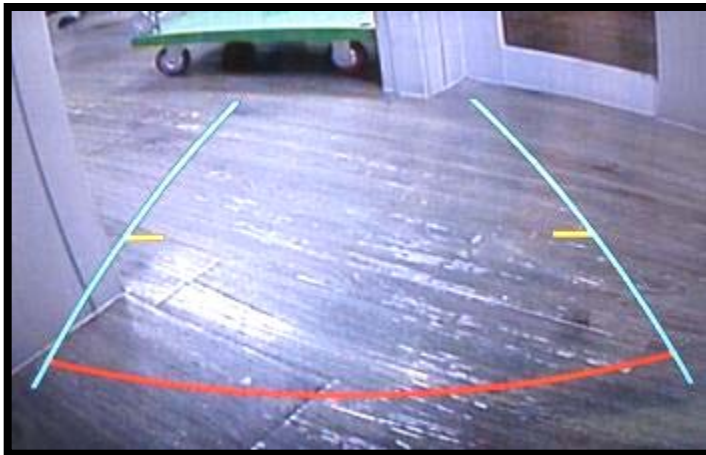

② After setting, once you put the gear to rear, the screen displays the parking guide line like the left picture no. 2.

How to use parking guide line

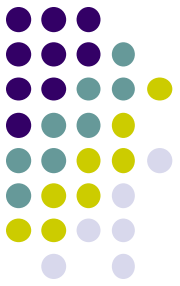

③

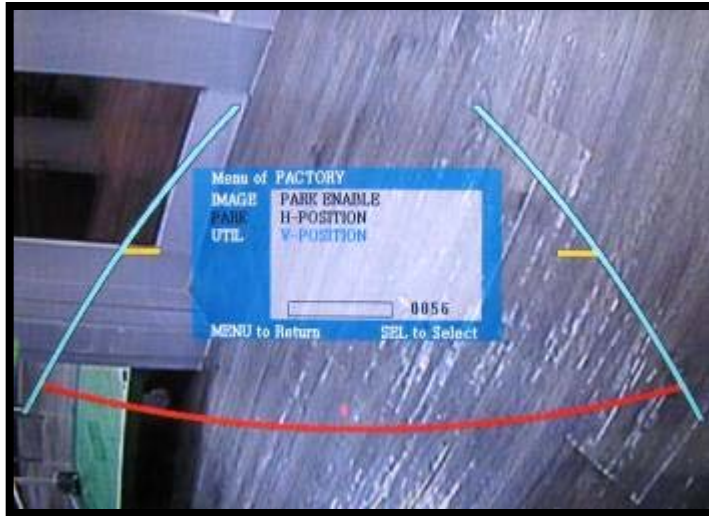

③ The way to move the lines

: Once you operate “*Factory Mode” again, when the lines are appeared, OSD image will be displayed like the left picture no.3

After that, you select “PARK” and can move the lines by ‘UP’,‘DOWN’ keys of keypad.

H-POSITION: Move to Left, Right

V-POSITION: Move to Up, Down

* **FACTORY Mode** : This all processes should be operated on ‘Factory Mode’ and ‘Factory Mode’ is operated with pressing UP->DOWN->UP->MENU keys of the keypad sequently.

Product Composition

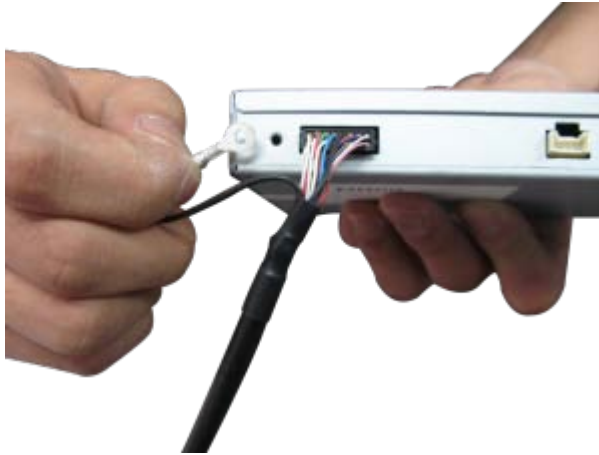
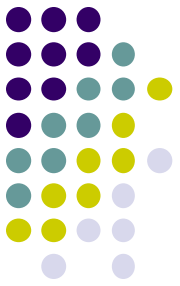

- Power Cable: 1 EA
- A/V Cable : 1 EA
- IR Cable : 1 EA
- Remote Control : 1 EA
- LCD Out Cable : 1 EA
- Data Input Cable : 1 EA
- NAVI Cable : 1 EA
- Toggle S/W : 1EA

Installation Structure

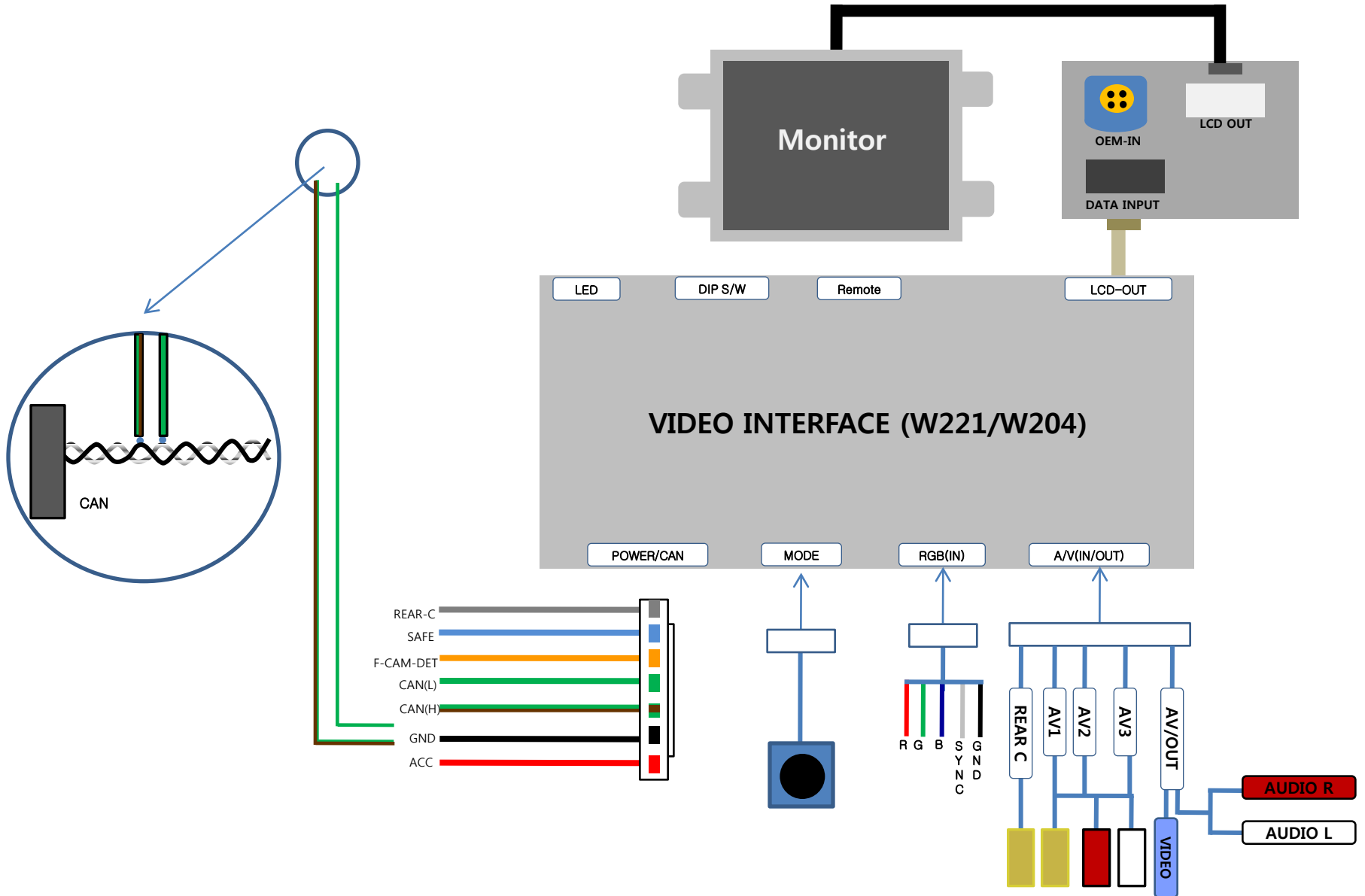

Installation Guide : New C-Class

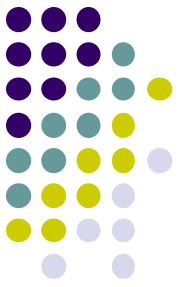

1. Air-Con Box Disassembly



Remove the Air-con Box with a proper tool.



Be careful with the connected cable when you take apart the air-con box.

Installation Guide : New C-Class

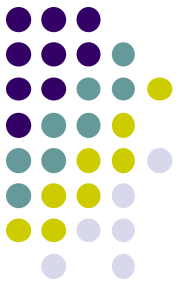

2. Monitor Disassembly



Take the monitor out from the car after removing the screws. Be careful with the cable connected to the monitor.

3. CAN Wiring & LCD In/Out Connection



Wire offered CAN wires with
CAN wires of the car.
White+Black : CAN HIGH
Black : CAN LOW

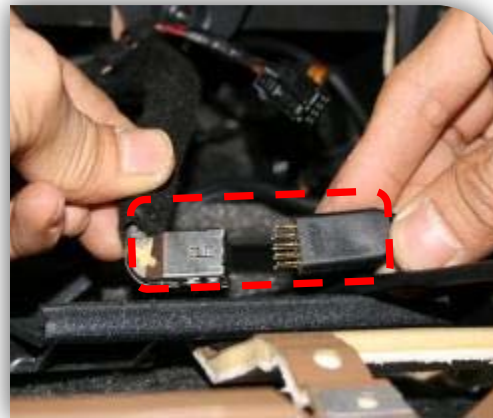

Connect LCD Out cable coming
from the car with LCD-In cable
offered with right position like
the picture.

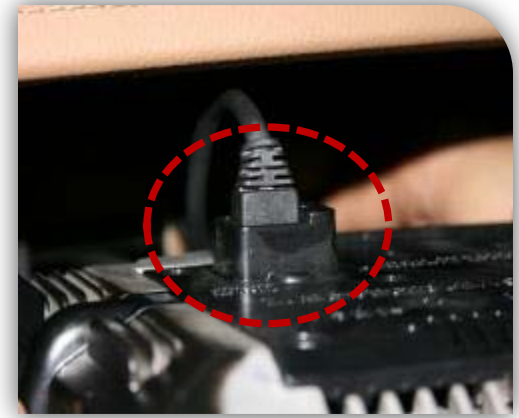

Connect LCD-Out cable to the
connector of the monitor.

Installation Guide : New S-Class

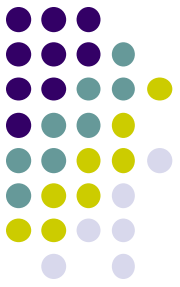

1. Glove Box Disassembly



Remove the screws of driver's seat ward, passenger's seat ward on the glove box with proper tools.



After detaching the air-con cover, remove the inside screw with a tool like the pictures.

Installation Guide : New S-Class



2. Glove Box Disassembly



Get the glove box separated from the car by pulling it.

3. Monitor Disassembly



Remove the protection cover at the monitor's top with a tool.

Remove the screw marked on the left picture, pull the left part out from the monitor like the right picture.

Installation Guide : New S-Class



Disassemble the monitor with removing screws like the pictures.

4.Cup Holder Disassembly



Remove the cup holder with screws.



Removed the parts marked on the above picture from the car.



Installation Guide : New S-Class



5. HEAD UNIT Disassembly (DVD Controller Box)



Remove the screws and take Head unit out from inside.

6. CAN Wiring & LCD In/Out Connection

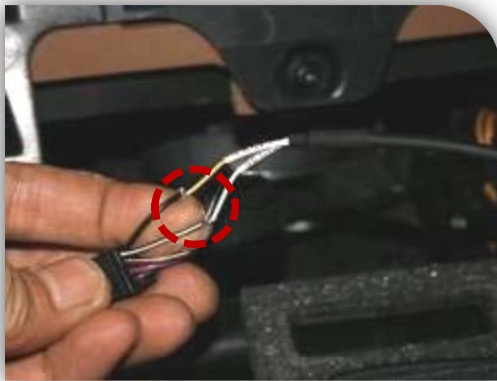

Wire offered CAN wires with
CAN wires of the car.
White+Black : CAN HIGH
Black : CAN LOW

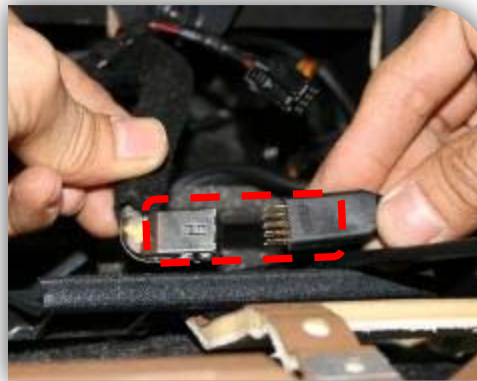

Connect LCD Out cable coming
from the car with LCD-In cable
offered with right position like
the picture.



Connect LCD-Out cable to the
connector of the monitor.

Installation Guide : New E-Class

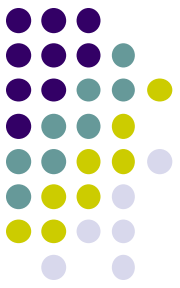

※To prevent shacking, Connect the GND in LCD cable to Car's monitor and Interface



<Interface board>

To use offered screw, Connect the GND to interface

<Monitor>

Connect the GND to Monitor like the picture above

FAQ

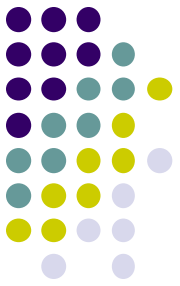

1. When can not change mode.
 - Check if the IR Cable (remote control) is connected or not.
 - Check if LED is turned on or not. If it is not turned on, Check if power cable is connected or not.
 - Check if CAN is connected well.

2. When the screen is displaying only black color.
 - Check if 2nd LED is turned on or not. If it is not turned on, please check all video sources that you will connect with the interface is operating well or not.
 - Check if interface is connected well.

3. When displayed color of screen is not proper. (If it's too dark or the color is not proper)
 - Try to push "Reset button" on the remote control. If the color of screen keeps on displaying wrong color, you have to ask manufacturer for the problem.
 - Try to adjust Color, Contrast, Brightness by the remote.

4. When Back-up camera is not displayed on the screen.
 - Turn Dip S/W no.7 on.

5. When the mode you set is not skip.
 - Check if Dip S/W is set in proper way.

6. When Main screen on the car is not displayed.
 - Check if In/Out cables are connected well. If it keeps showing the same problem, you have to ask manufacturer for the problem.

7. When the screen is displaying only white color.
 - Check if out cable is connected well. If it keeps showing the same problem, you have to ask manufacturer for the problem.